

99059

Dimensions

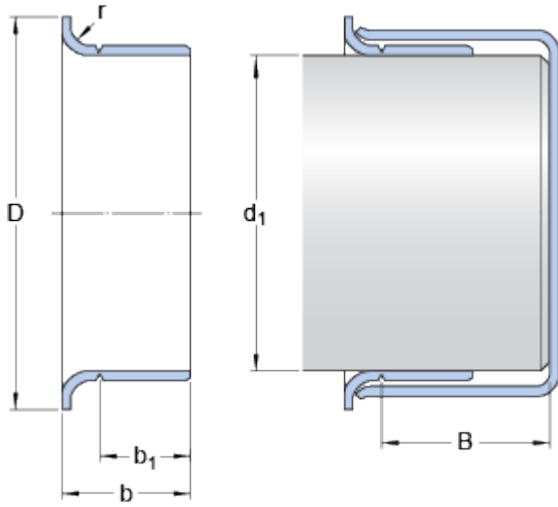

Nominal dimensions

d_1		15	mm
D		19.05	mm
Tolerance outside diameter D	\pm	1.6	mm
b		8.992	mm
Tolerance width b	\pm	0.8	mm
b_1		5.004	mm
Tolerance width b_1	\pm	0.8	mm
B	max.	47.295	mm
r	max.	3.18	mm

Shaft diameter range

d_1	min.	14.961	mm
d_1	max.	15.062	mm